

**Parts List**

*Lista de Partes*

- 1-Wall Mounted Outlet
- 1-Pre-Loaded Wall Gasket

- 1-Salida de Pared
- 1-Empaque Instalado

(TGS Recommended installation view as shown)  
(TGS Vista de instalación recomendada mostrada)

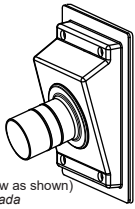

**TGS Series**

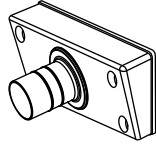

**TSS Series**

(TSS Recommended installation view as shown)  
(TSS Vista de instalación recomendada mostrada)



4-Anti-Corrosion, All-Material, Tap Screws w/Neoprene Washers

4-Tornillos de Todo Material y Anti-Corrosivos con Arandela Neoprene



1-Adjustable Hose Clamp

1-Abrazadera Ajustable de Manguera

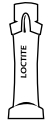

1-Lubricant  
1-Lubricante

**Dimensions**

*Dimensiones*

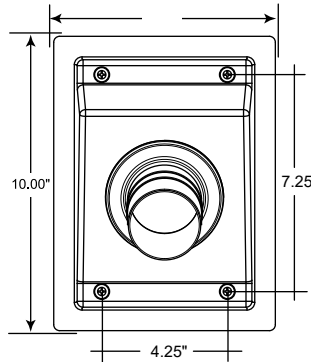

**Tools Required**

*Herramientas Requeridas*

- 1/8" Drill Bit Size  
(Use appropriate bit type for surface to be drilled.)
- 5/16" Hex Head Driver
- 1/8" **Tamaño de Broca**  
(Use el tipo de broca apropiado para la superficie para ser taladrada.)
- 5/16" **Dado con Cabeza Hexagonal**

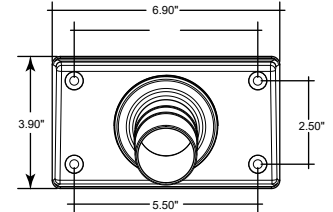

**Installation Instructions**

*Instrucciones de Instalación*

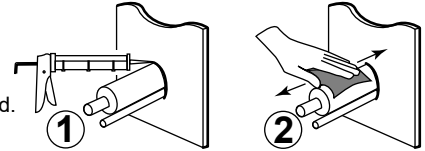

- 1 Important** - Before installing, make sure that the existing wall penetration has been properly sealed.  
*Importante* - Antes de instalar, asegure que la penetración de la pared este completamente sellada.
- 2 Important** - Clean and heavily lubricate line set materials with lubricant or soap. This step will prepare and facilitate a proper seal installation.  
*Importante* - Limpie y lubrique bastante los materiales de línea de refrigeración con lubricante o jabon. Este paso de preparación hara la instalación fácil, para asegurar un sello apropiado.

- 3** Lubricate the inside sleeve area (TITAN Outlet™) and fit over lubricated Insulation/Line Set Radius, begin to push/slide outlet into line set and towards wall.  
*Lubrique la area interna del ducto (TITAN Outlet™) y monte encima de la línea de refrigeración ya lubricada y empiece a empujar y resvalar la parte de enchufe hacia la pared.*

- 4** Once Outlet fits flush with wall, proceed to drill 3/16" or 1/8" pilot holes for fasteners.  
*Ya que el enchufe este posicionado encima de la pared, proceda a hacer abujeros pilotos de 3/16" o 1/8" para los tornillos.*

- 5** Drive the provided gasket fasteners into the wall. Make sure the outlet wall gasket has a minimum 30% compression to ensure a proper airtight seal.  
*Atornille los tornillos de sello en la pared. Asegure que la parte de enchufe y que el sello de pared ya montado, tenga una compresion de 30% minima para asegurar un sello hermético.*

- 6** Tighten the provided stainless steel clamp to ensure proper air seal and pipe & insulation support and security. This will also ensure anti-vibration support, wind protection, anti-seismic bracing and anti-rodent sealing.  
**NOTE: Refer to back for insulation protection instructions, as per IECC National Energy Code.**  
*Apriete la abrazadera ajustable de acero inoxidable para asegurar un sello hermético y con soporte y seguridad para el aislamiento de tuberías. Esto asegurara soporte contra-vibración, protección contra-viento, soporte contra-sísmico y un sello contra-roedores.*  
**NOTA: Refiera atras para instrucciones de protección para el aislamiento de tubería por el IECC Código de Energía Nacional.**

- 7 Important** - Caulk around the entire wall outlet surface edge, using an exterior-use silicone caulking.  
*Importante* - Selle enteramente alrededor del la parte de enchufe y la pared, use silicone para uso exterior.

- 8 Important** - Visually inspect and caulk any small gaps that may appear between pipes and insulation areas, to ensure that all gaps inside the sleeve area are completely sealed. If needed or preferred, caulk and encapsulate entire inside radius of the sleeve area with exterior-use silicone.  
*Importante* - Visualmente inspeccione y selle cualquier erradura que aparesca entre la area de la pipa y el aislamiento para asegurar que la area interna del ducto este completamente sellada. Si se requiere o prefiere, selle o encapsule con silicone completamente alrededor de la area interna del ducto.

Protects Piping Insulation

## Installation Instructions

- 1 Measure line-set from Condensing Unit to wall outlet and cut E-FLEX GUARD™ to length.
- 2 Wrap E-FLEX GUARD™ Insulation Protector around line-set making sure pre-loaded Velcro fasteners are fully enclosed. Ensure seam faces toward the bottom for improved aesthetics.
- 3 Secure around flexible elastomeric sleeve with enclosed stainless steel hose clamp. Tighten for proper seal and security.

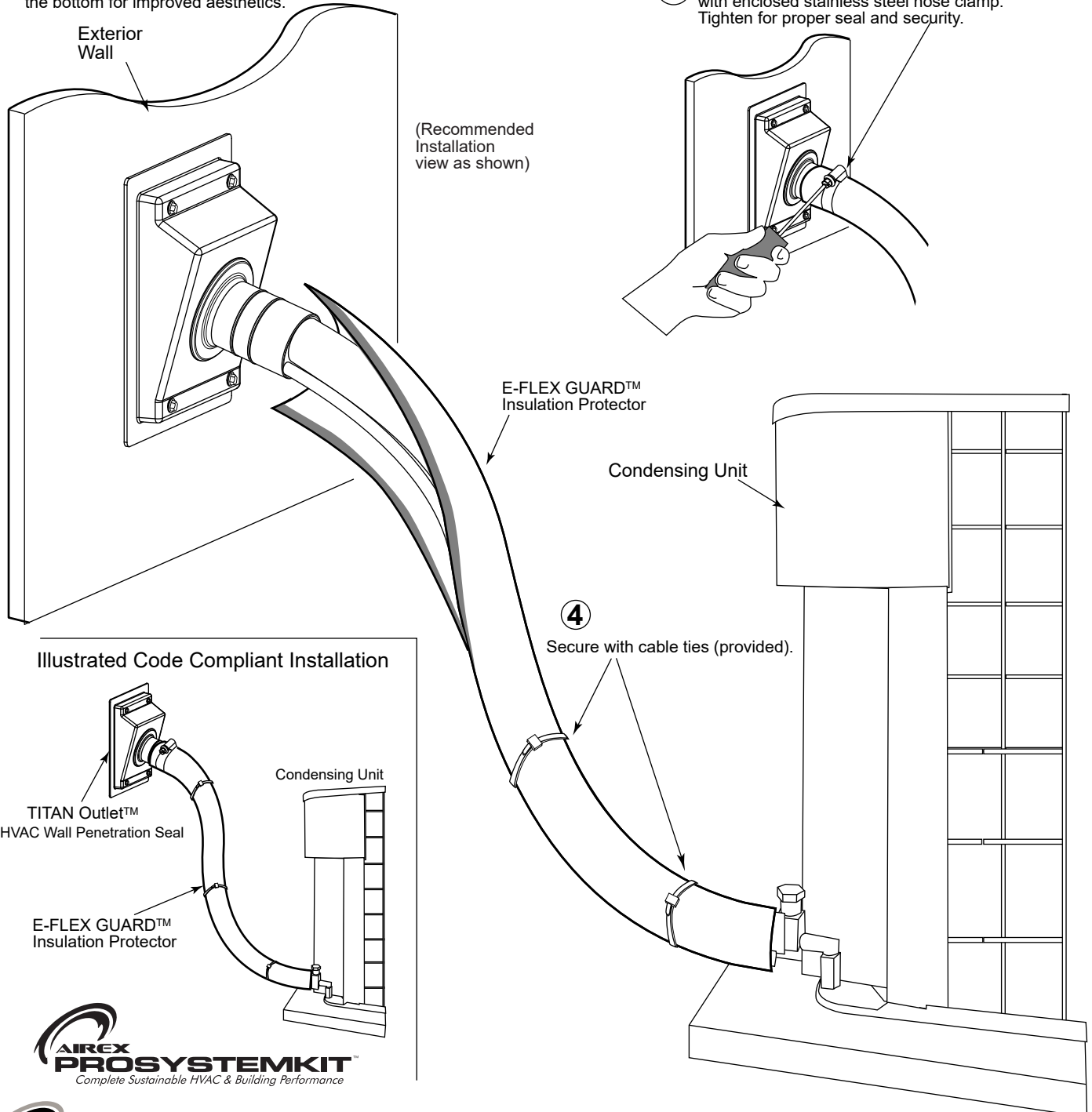

**AIREX  
PROSYSTEMKIT™**  
Complete Sustainable HVAC & Building Performance



**AIREX**  
Manufacturing Inc.